



扫描二维码
关注康力电梯门户网站
Scan the QR code and pay attention to
CANNY ELEVATOR Portal Website



扫描二维码
关注康力电梯微信公众号
Scan the QR code and pay attention to
CANNY ELEVATOR WeChat Public Number

KONL® 康力电梯
CANNY ELEVATOR

KLJ 家用电梯

KLJ-Home use elevator



康力电梯股份有限公司

CANNY ELEVATOR CO.,LTD.

- ◎地址：江苏省汾湖高新技术产业开发区康力大道888号
- ◎电话：0512-63290000
- ◎传真：0512-63293938
- ◎网址：www.canny-elevator.com
- ◎电子信箱：(国内) marketing@canny-elevator.com
(国外) export-canny@163.com
export@canny-elevator.com
- ◎400客户服务热线：400-188-2367
- ◎邮编：215213

- ◎Add: No.888, Kangli Road, FOHO New & Hi-Tech Industrial Development Zone, Jiangsu Province, China.
- ◎Tel: +86-512-63290000 63297851
- ◎Fax: +86-512-63299709
- ◎URL: www.canny-elevator.com
- ◎E-mail: export-canny@163.com
export@canny-elevator.com
- ◎P.C:215213



开启电梯 家电时代

Open the era of elevator home appliance



康力家用系列电梯

突破格局之变，创造更多空间可能；
多重安全保护，给予家人无限关怀；
绿色节能科技，开启电梯家电时代。

CANNY ELEVATOR home series elevator

Break the traditional structure, create more spatial possibilities;
Multiple security protection, give families more care;
Green and energy-saving technology, open the era of elevator home appliance.

无机房井道——
(Machine roomless shaft)



龙门架结构
Gantry structure

220V家用电源，1.1KW低耗能
220V household power supply, 1.1 KW low power consumption



自由布局 化整为零 领略建筑之上尊崇体验

Free layout break up the whole into parts Experience the worship above architecture

更先进的无机房结构

> 性能优异凸显，绝无仅有结构体验。

占地面积小、土建要求低，满足不同类型别墅结构。

More advanced (machine roomless structure)

Excellent elevator performance, unique structure experience. Small occupation area, low civil requirements, can meet the needs of different types of villa structure.

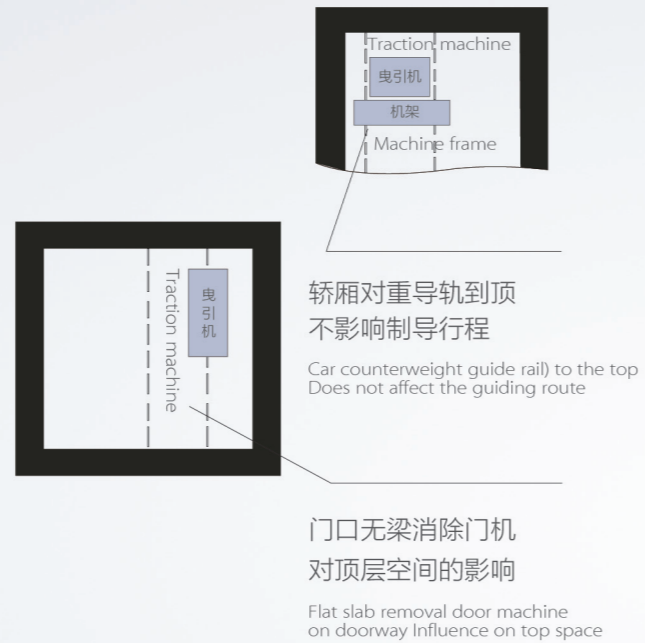

更便捷的主机安装结构

> 适用主机导轨安装，去除预留孔位，极简安装，自在创享。

More convenient installation structure of the main machine

> Main machine installation, eliminate reserved holes, simple installation, free to enjoy.

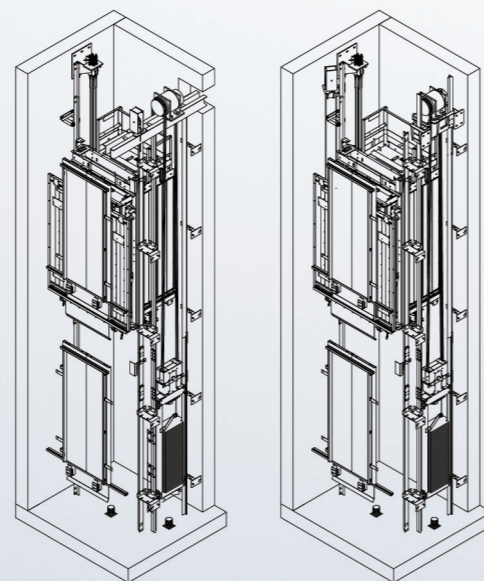

紧凑布置

> 更高的井道利用率；释放家庭空间，预留你对生活的设计品味。

Compact layout

> Higher utilization; release family space, reserve for your life design taste.



灵活空间布置
Flexible space layout

时尚家电
Fashion appliance



灵动生活 自在上下 全方位关爱您和您的家庭

Smart living, free lifting
Comprehensively care for you and your family

永磁同步门机系统

- > 优化的S曲线，梯门开关更平稳，有效减少运行噪音，家庭环境更舒适。
- > 专为老人和孩子设计的平缓运行系统，拥有最舒适的速度运行曲线，启动平稳柔顺。
- > 高度灵敏光幕门保护，有效防止轮椅老人及小孩发生夹伤事故。
- > 采用结合工控技术与通讯技术的一体式控制柜，全钢板封闭设计，维护方便。

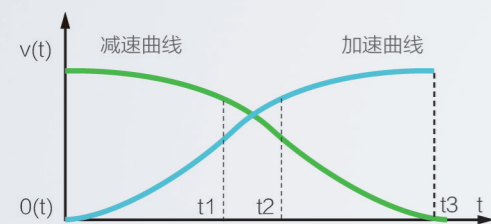

最舒适的速度运行曲线



维护方便

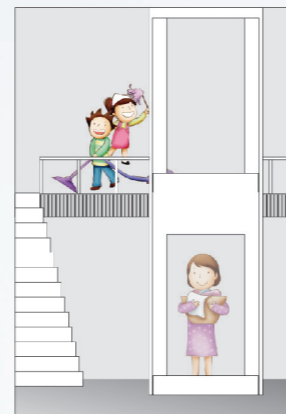

Permanent magnet synchronous door machine system

- > Optimized S-curve and smooth opening and closing operation of elevator door can effectively reduce operating noise, and create a more comfortable home environment.
- > High-sensitive light curtain door protection can effectively prevent jam accidents of the elderly in wheelchairs and small children.
- > Smooth operation system specially designed for the elderly and children has the most comfortable speed running curve, ensure a smooth and stable starting.
- > Integrated control cabinet combined industry control technology with communication technology is adopted, closed design of entire steel plate, can achieve convenient maintenance.

龙门架加拉杆结构更稳定

- > 龙门架式轿架加拉杆结构，双重稳定结构，使轿厢运行更舒适平稳。

More stable gantry rod structure

- > Gantry car frame with rod structure, double stable structures to make the car running more comfortable and steady.

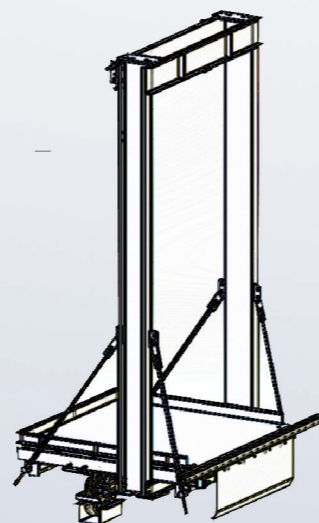

平缓运行系统
Smooth operation system





全LED照明系统
All LED lighting system



家电时代 节能风暴 致敬未来生活的最大诚意

Home appliance era energy-saving storm
Pay the greatest sincerity to future life



全LED照明系统 All LED lighting system

节能设计

- > 采用永磁同步无齿轮曳引机，可节省能源40%以上为你省下一大笔电费。
- > 全LED照明系统，维保频率低，使用寿命长，比普通灯管节能近60%。
- > 轿厢一定时间无人使用，照明系统和风扇将自动关闭。接到召唤命令后再自动打开，有效降低你的家用能耗。



40%
节省能源 ↓

Energy-saving design

- > Use permanent magnet synchronous gearless traction machine, can save energy by more than 40%, and a lot of electricity fee for you.
- > All LED lighting system, low maintenance rate, long service life, can save energy by nearly (60%) than ordinary lamps.
- > In case of no one using the car, the lighting system and the fan will automatically shut down. Reopen upon receiving call command, can effectively reduce your household consumption.



LED
轿内照明

节能家电

- > 220V家用电源，1.1KW低耗能制动，耗电量相于冰箱等电器，成为你真正的节能家电。

Energy-saving home appliance

- > 220V household power supply, 1.1KW low energy consumption for braking, power consumption is far less than that of other electrical appliances such as refrigerator, become your true energy-saving appliance.

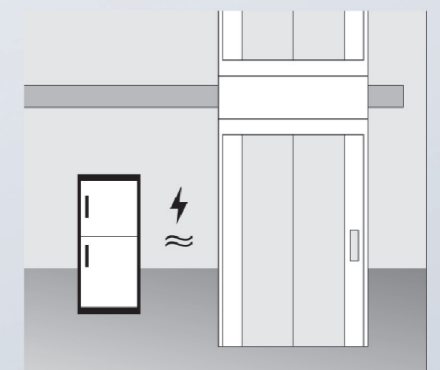



标准型设计

Standard design

KL/J3-001

吊顶：KL/DD-4004
 喷粉钢板，中撑小圆孔，LED光源
 轿壁：发纹不锈钢
 前壁：发纹不锈钢
 操纵箱：KL231C，发纹不锈钢
 轿门：发纹不锈钢
 地板：单色PVC
 踢脚线：发纹不锈钢

Ceiling: KL/DD-4004, dusting steel plate,
 middle supporting small hole, LED light source
 Car wall: Hairline stainless steel
 Front wall: Hairline stainless steel
 Control box: KL231C, Hairline stainless steel
 Car door: Hairline stainless steel
 Floor: Monochrome PVC
 Flooring angular line: Hairline stainless steel



扫描二维码360度了解轿厢
 Scan the QR code to know more about the lift car in the 360-degree manner

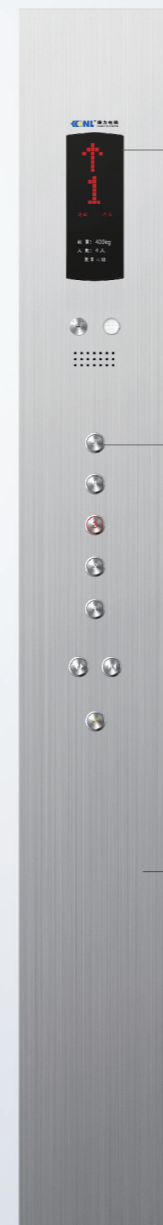

显示屏
 Display screen



圆形微行程按钮
 Circular micro-trip button



方形微行程按钮
 Square micro-trip button

发纹不锈钢
 Hairline stainless steel

一体式操纵箱
 Integrated control box

KL231C

家用系列电梯 | KLJ-Home series elevator



LED照明设计

具有稳定，温度低，无辐射，寿命长等优势

LED lighting design

Has advantages such as stability, low temperature, no radiation, long service life, etc

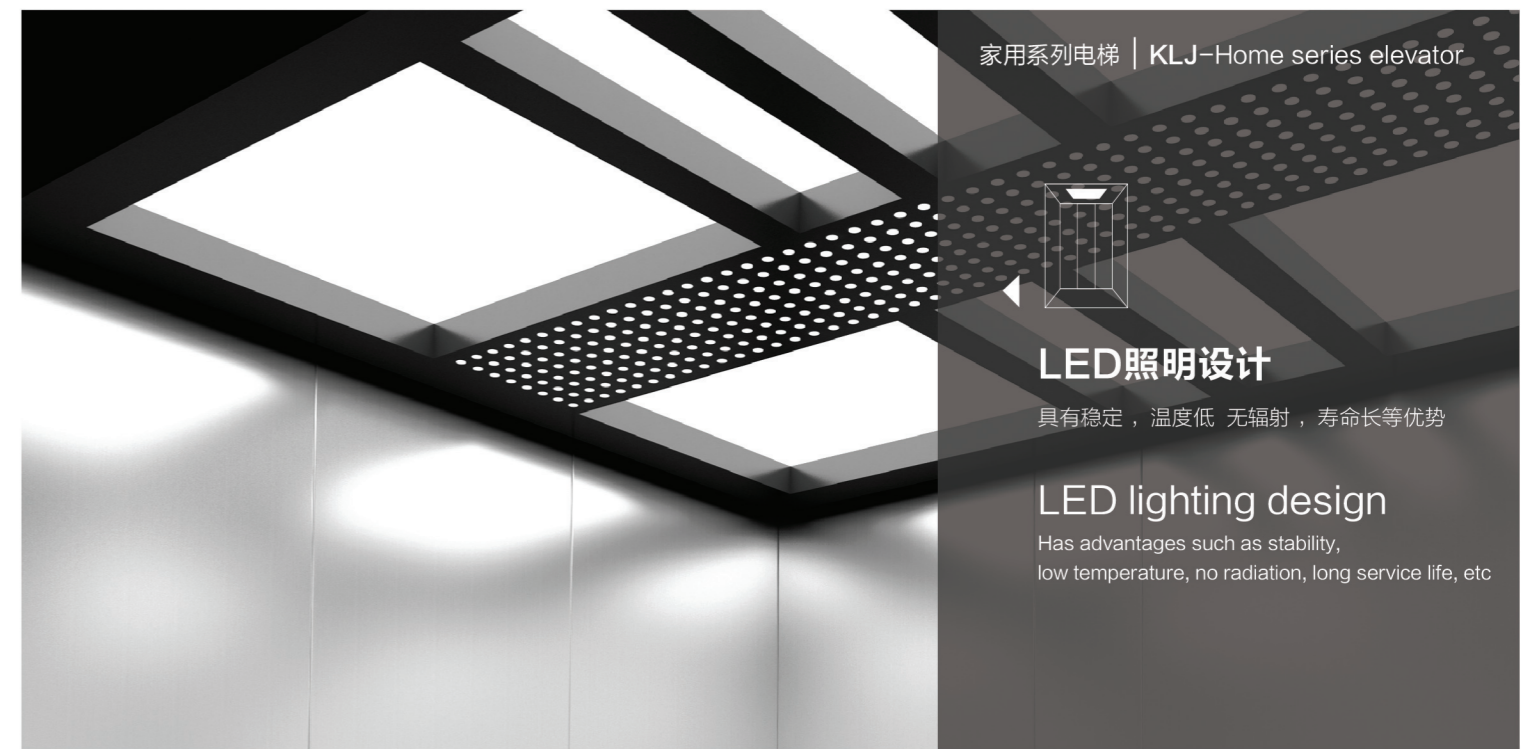

一体式操纵箱

美观大方，简约时尚型设计

Integrated operation panel

Elegant and generous appearance, simple but fashionable design



选配型设计

Optional design



扫描二维码360度了解轿厢
Scan the QR code to know more about the lift car in the 360-degree manner



KL/J3-002

吊顶：KL/DD-4004
喷粉钢板，中撑小圆孔，LED
轿壁：发纹不锈钢，木纹贴塑钢板
前壁：发纹不锈钢
操纵箱：KL231C，发纹不锈钢
轿门：发纹不锈钢
地板：单色PVC
踢脚线：发纹不锈钢
扶手：KL-FS 001

Ceiling: KL/DD-4004, dusting steel plate, middle supporting small hole, LED light source
Car wall: Hairline stainless steel, wood plastic coated steel plate
Front wall: Hairline stainless steel
Control box: KL231C, Hairline stainless steel
Car door: Hairline stainless steel
Floor: KL/JDJ-4001, monochrome PVC
Flooring angular line: Hairline stainless steel
Handrail: KL-FS 001



KL/J4-001

吊顶：KL/DD-J001木质框架，镜面不锈钢，LED光源
轿壁：木饰面，木线条造型，美容镜，墙纸
前壁：镜面不锈钢
操纵箱：KL330，镜面不锈钢
轿门：镜面不锈钢
地板：大理石拼花
踢脚线：木质烤漆

Ceiling: KL/DD-J001 Wooden frame, mirror stainless steel, LED light source
Car wall: Wood veneer, wooden line modeling, beauty mirror, wallpaper
Front Wall: Stainless steel mirror
Control box: KL-330, stainless steel mirror
Car door: Stainless steel mirror
Floor: Marble mosaic
Flooring angular line: Wooden paint



扫描二维码360度了解轿厢
Scan the QR code to know more about the lift car in the 360-degree manner



KL/J4-002

吊顶：KL/DD-J002木质烤漆，金箔，LED光源
轿壁：木饰面+钛金镜面蚀刻不锈钢
前壁：钛金镜面不锈钢
操纵箱：KL-330，钛金镜面不锈钢
轿门：钛金镜面不锈钢
地板：印刷PVC
踢脚线：木质烤漆
扶手：KL-FS 012

Ceiling: KL/DD-J002 Wooden paint, gold foil, LED light source
Car wall: Wood veneer, titanium mirror etched stainless steel
Front wall: Titanium mirror stainless steel
Control box: KL-330, Titanium mirror stainless steel
Car door: Titanium mirror stainless steel
Floor: PVC printing
Flooring angular line: Wooden paint
Handrail: KL-FS 012

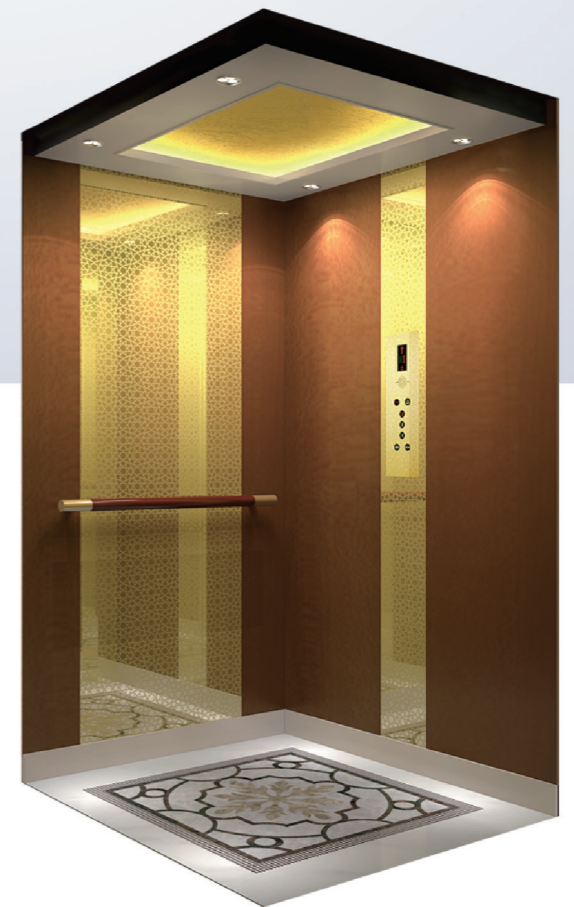

扫描二维码360度了解轿厢
Scan the QR code to know more about the lift car in the 360-degree manner



扫描二维码360度了解轿厢
Scan the QR code to know more about the lift car in the 360-degree manner



KL/J4-003

吊顶：KL/DDJ-4005
镜面不锈钢+亚克力，LED光源
轿壁：发纹不锈钢+镜面不锈钢+装饰画+大理石
前壁：镜面不锈钢
操纵箱：KL231C，发纹不锈钢
轿门：镜面不锈钢
地板：大理石拼花
踢脚线：镜面不锈钢

Ceiling: KL/DDJ-4005, Stainless steel mirror, acrylic, LED light source
Car wall: Hairline stainless steel, stainless steel mirror, decorative painting, marble
Front wall: Stainless steel mirror
Control box: KL231C, Hairline stainless steel
Car door: Stainless steel mirror
Floor: Marble mosaic
Flooring angular line: Stainless steel mirror



扫描二维码360度了解轿厢
Scan the QR code to know more about the lift car in the 360-degree manner



KL/J4-005

吊顶：KL/DDJ-4003木框+LED光源+灯带
后壁：木饰面+装饰画+PVC墙纸+木线框
侧壁：木饰面+镜面不锈钢
前壁：镜面不锈钢
操纵箱：钛金扶手式操纵箱
轿门：镜面不锈钢
地板：印刷PVC
踢脚线：木饰面

Ceiling: KL/DDJ-4003, Wooden frame, LED light source, light belt
Backwall: Wood veneer, decorative picture, PVC wallpaper, wooden wire frame
Sidewall: Wood veneer, Stainless steel mirror
Front wall: Stainless steel mirror
Control box: Titanium-made handrail type maneuvering box
Car door: Stainless steel mirror
Floor: Printing PVC
Flooring angular line: Wood finishes



扫描二维码360度了解轿厢
Scan the QR code to know more about the lift car in the 360-degree manner



KL/J4-004

吊顶：KL/DDJ-4004，烤漆木板及线条+LED光源+灯带
后壁：木饰面及线条+镜面
侧壁：木饰面及线条+化妆镜
前壁：镜面不锈钢
操纵箱：KL-330
轿门：镜面不锈钢
地板：印刷PVC
踢脚线：木饰面

Ceiling: KL/DDJ-4004, baking varnished wooden board and lines, LED light source, light belt
Backwall: Wood veneer and lines, mirror face
Sidewall: Wood veneer and lines, cosmetic mirror
Front Wall: Stainless steel mirror
Control box: KL-330
Car door: Stainless steel mirror
Floor: Printing PVC
Flooring angular line: Wood finishes



扫描二维码360度了解轿厢
Scan the QR code to know more about the lift car in the 360-degree manner



KL/J4-006 用户自理二次装潢

吊顶：KL/DDJ-4002，喷粉钢板（冰灰）+长形LED光源
轿壁：喷粉钢板（冰灰），用户自理二次装潢
操纵箱：KL-330
地板：印刷PVC
踢脚线：发纹不锈钢

Ceiling: KL/DDJ-4002, dusting steel plate (Ice gray), long-shaped LED light source
Car wall: dusting steel plate (Ice gray), users prepare for secondary decoration
Control box: KL-330
Floor: Printing PVC
Flooring angular line: Hairline stainless steel



吊顶选配设计

Ceiling optional design



KL/DDJ-4002

轿顶板：喷粉钢板（冰灰） 照明：长形LED光源

Car-top plate: Dusting steel plate
Lighting: Long-shaped LED light source



KL/DDJ-4003

轿顶板：木框+喷粉钢板 照明：LED光源+灯带

Car-top plate: Wooden frame, dusting steel plate
Lighting: LED light source, light belt



KL/DDJ-4004

轿顶板：烤漆木板及线条 照明：LED光源+灯带

Car-top plate: Baking varnished wooden board and lines
Lighting: LED light source, light belt



KL/DDJ-4005

轿顶板：镜面不锈钢 照明：透明亚克力灯柱，LED光源

Car-top plate: Stainless steel mirror
Lighting: Transparent acrylic lamp post, LED light source

PVC地板（可选）PVC Floor (optional)

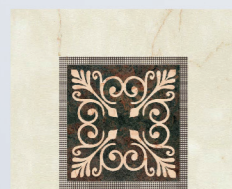

KL/JD-4001

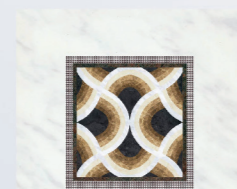

KL/JD-4002

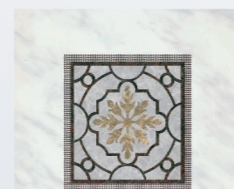

KL/JD-4003



KL/JD-4004



KL/JD-4005



KL/JD-4006



KL/JDJ-4003



KL/JDJ-4004

扶手（可选）Handrail (optional)

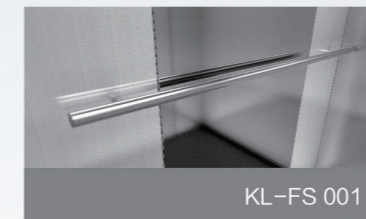

KL-FS 001

发纹不锈钢单管
Stainless steel hairline mono-tube

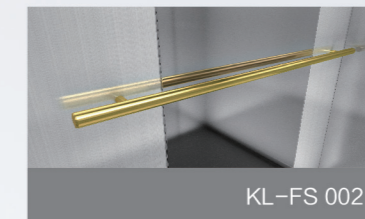

KL-FS 002

镜面钛金不锈钢单管
Titanium gold mirror stainless steel mono-tube

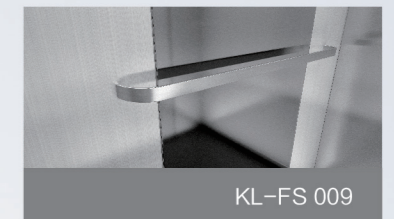

KL-FS 009

不锈钢短纹，圆弧头
Short grain stainless steel, arc head

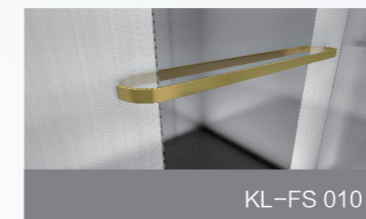

KL-FS 010

不锈钢钛金短纹，圆弧头
Short grain titanium gold stainless steel, arc head

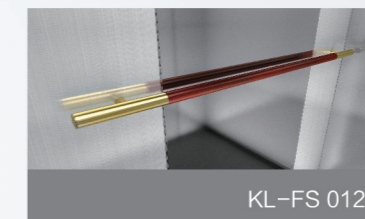

KL-FS 012

圆木和钛金组合
Combination of round wood and titanium gold

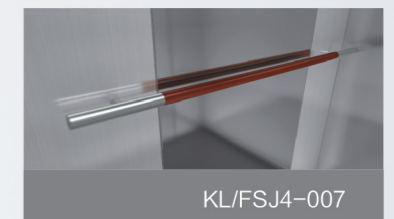

KL/FSJ4-007

圆木和镜面不锈钢组合
Combination of round wood and mirror stainless steel

不锈钢色标(可选) Stainless steel color standard (optional)



SUS304发纹不锈钢
Hairline stainless steel

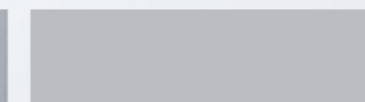

SUS304镜面不锈钢
Stainless steel mirror



SUS304发纹蚀刻不锈钢
Stainless steel etched hairline



SUS304镜面蚀刻不锈钢
Stainless steel etched mirror



SUS304钛金发纹不锈钢
Stainless steel titanium gold hairline

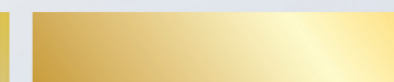

SUS304钛金镜面不锈钢
Stainless steel hairline

贴塑钢板色标（可选）Plastic steel plate color sticker (optional)

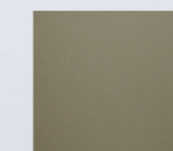

A119 金沙纹
Gold sand pattern

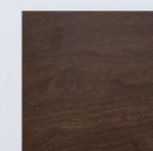

B103 红木
Red wood

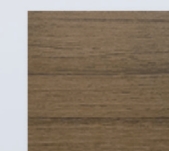

B107 深柚木
Dark teak

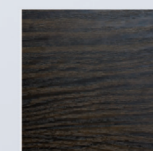

B125 黑檀木
Black sander

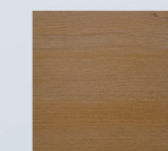

C102 花梨木
Rosewood



C127 鑫丝铂
Platinum wire



人机界面选配设计

Optional design of man-machine interface

一体式操纵箱 Integrated operation panel



无底盒召唤指示器 Calling Indicator Without Bottom Box



安装方式对比 Installation methods contrast

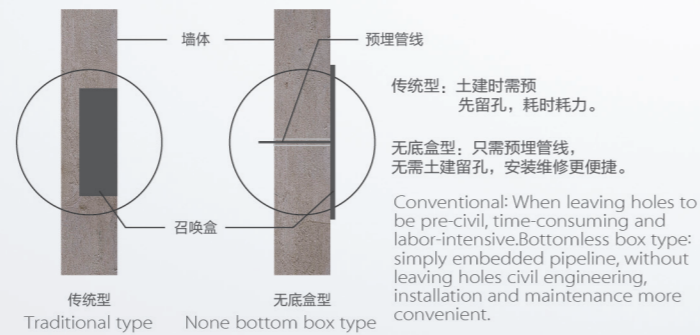

嵌入式操纵箱 Embedded operation panel



喷粉色标-可选 Dusting color standard (optional)



厅门系列 Landing door series



KL-TM 001

厅门：发纹不锈钢 门套：发纹不锈钢
Landing door: Hairline stainless steel
Small Jamb: Hairline stainless steel
标配 (optional)

KL-TM 005

厅门：发纹不锈钢，玻璃 门套：发纹不锈钢
Landing door: Hairline stainless steel frame, glass
Small Jamb: Hairline stainless steel
可选 (optional)

KL/M-4025

厅门：镜面蚀刻镀玫瑰金 门套：玫瑰金不锈钢
Landing door: Mirror Etching With Rose Gold Plating
Jamb: Rose gold stainless steel
可选 (optional)

KL/M-4028

厅门：镜面蚀刻 门套：发纹不锈钢
Landing door: Mirror etching
Jamb: Hairline stainless steel
可选 (optional)

操纵箱型号 Model	面板材质 Panel material	按钮 Button	显示屏 Display screen	停层数 Parking number
KL232C	发纹不锈钢 Hairline stainless steel	方形微行程按钮 Square micro-stroke button	点阵显示屏 Dot matrix display screen	2 ~ 5停层 2 ~ 5 parking floors
KL233C	发纹不锈钢 Hairline stainless steel	圆形微行程按钮 Round micro-stroke button	液晶显示屏 Liquid crystal display screen	2 ~ 5停层 2 ~ 5 parking floors
KL234C	发纹不锈钢 Hairline stainless steel	方形微行程按钮 Square micro-stroke button	液晶显示屏 Liquid crystal display screen	2 ~ 5停层 2 ~ 5 parking floors
KL235C	发纹不锈钢 Hairline stainless steel	圆形微行程按钮 Round micro-stroke button	7" TFT-LCD 7" TFT-LCD	2 ~ 5停层 2 ~ 5 parking floors
KL236C	发纹不锈钢 Hairline stainless steel	方形微行程按钮 Square micro-stroke button	7" TFT-LCD 7" TFT-LCD	2 ~ 5停层 2 ~ 5 parking floors



● 安全回路保护 Safety loop protection

各安全装置的保护开关构成安全回路，安全回路断开，电梯将立刻停止运行。
Protection switch of various safety devices compose the safety loop. When safety loop disconnects, the elevator stops immediately.

● 抱闸检测保护 Brake detection protection

通过抱闸臂检测开关对抱闸的打开与闭合实时监测。当抱闸未按要求打开时，系统将禁止电梯启动。
Brake arm detection switch executes real-time monitor to brake opening / closing. If the brake does not open as per the requirements, the system will not allow the elevator start.

● 光幕保护 Light curtain protection

电梯关门过程中，进出轿厢的人或物遮挡光幕时，关门中转为开门或门保持开启状态。
In the process of door shut, when anybody / object that enters into / exit from the elevator car hinders light curtain, the door re-opens or keeps open.

● 门区外不能开门的保护 Protection of none door opening outside door zone

在非门区状态，禁止自动开门。
Automatic door opening is forbidden under none door zone condition.

● 超速保护 Overload protection

为防止速度超出控制范围的运行导致的安全问题,实施此保护。
The protection functions to prevent the speed from exceeding the controlled range and causing any safety problem(s).

● 超载报警指示 Prompt of overload alarm

在电梯关门运行前，当检测到超载信号时，超载蜂鸣器鸣响发出报警声并点亮超载指示灯。超载消除后自动恢复正常。
Before the elevator shuts the door, if it detects overload signal, overload buzzer rings. It alarms and brightens overload indicating lamp. After it removes overload problem, it re-starts automatically.

● 故障自动靠站 Automatic parking in trouble

正常运行中的电梯因故障在非平层区域内停止时，只要不是安全装置动作而引起，则电梯以低速向中间楼层方向进行自救运行，并在最近服务层停层开门，以防止困人事故的发生。
When the elevator stops in none leveling zone due to any trouble, if it is not caused by safety device action, it executes self-rescue running towards the middle floor direction at low speed. It parks and opens the door at the nearest service floor to prevent from any trapping accident.

● 轿厢应急照明 Emergency car lighting

出现停电的情况时，安装在轿厢吊顶或操纵箱内的应急灯将自动亮起。
When power supply disconnects, emergency lamp at the car ceiling or in the operation box brightens automatically.

● 基站锁梯 Home landing elevator locking

电梯处于自动状态，关闭基站锁梯开关后，电梯将所登记的轿内指令服务完毕后自动返回基站，电梯进入驻停状态。一旦打开锁梯开关，电梯会立即退出驻停状态，投入正常运行。
When the elevator is under automatic condition, after it shuts home landing locking switch, the elevator will complete all the registered car command services, automatically return to home landing, it enters into parking condition. As soon as locking switch opens, it immediately exits from parking condition and throws into normal running.

● 全集选控制 All selective collective running

在候梯厅设置一个向上和一个向下层站召唤按钮，根据轿内指令和层站召唤自动判断电梯的运行方向，并上下顺向依次应答各个轿内指令和层站召唤信号。
Waiting hall has one up and down calling button respectively. It automatically judges the elevator running direction according to the car command and landing calling. It responds various car commands and landing calling signals one by one from up to down sequence.

● 误登记取消 Cancel the error-register

若乘客误按了某层轿内指令按钮并已登记（轿内指令灯亮），则在电梯未运行状态下，只需再按一次 该层轿内指令按钮即将该登记取消（轿内指令灯灭）。
If the passenger presses the car command button at certain floor and has registered it by mistake, (by then the car indicating lamp is bright), under the condition of none elevator running, you only require to press the car command button at the same floor to cancel the register. (By then the car indicating lamp dies out.)

● 闲时轿厢内照明及风扇自动停止 Automatic stop of the car lighting and fan

如一定时间电梯无人使用，轿厢内照明和风扇将自动关闭。接到任何层站召唤命令后自动打开。
If nobody uses the elevator within certain period of time, the car lighting and fan shut off automatically. It re-opens at receiving any landing calling command(s).

● 满载直驶 Full-load straight travel

当轿厢内载重超过额定载重的80%时，将不响应层站召唤，只响应轿内指令。
When the car load exceeds 80% of load rating, it does not respond any landing calling. It only responds the car command(s).

● 楼层信号自动校正 Automatic correction of floor signal

如果楼层显示位置有误差，系统在运行中检测到端站开关后，将自动校正楼层显示。
If the floor display position has error, after the system detects terminal switch in the travel, it will automatically correct the floor display.

● 轿内反向指令消除 Cancel reverse command(s) in the car

当电梯运行至最远端楼层换速时，清除所有的轿内指令登记。
When the elevator travels to the farthest floor and changes the speed, it removes all the car command register.

● 呼梯按钮嵌入自诊断 Self-diagnostic embedded calling button

若某一层站召唤按钮按下时间超过20秒而未断开，则系统认为该按钮嵌入。以后对该层层站召唤不予登记，且该按钮对应的应答灯不断闪烁报警。当该按钮断开时，退出上述状态。
If press calling button at certain landing for over 20 second, then it still does not disconnect, the system assumes that it is embedded button. It does not register the landing calling of the same floor afterwards. Responsive lamp which corresponds to the button keeps flickering and alarming. When the button disconnects, it exits from above condition.

● 自动返基站 Automatic return to home landing

无司机运行时，如果自动返基站功能设置有效，当无层站召唤信号时间到达预定的时间后，电梯自动返回基站。
In no-operator running, if automatic return function to home landing is still effective, when no-landing calling signal time fulfills preset time, the elevator returns to home landing automatically.

● 轿厢到站钟 Car arrival gong

通过轿厢顶的钟声，提醒在轿厢内的乘客和等候在电梯候梯厅内的乘客该电梯即将到站。
Arrival gong at the car top reminds the passengers in the car and those waiting in the hall that the elevator comes.

● 停电应急平层运行 Automatic emergency leveling travel

电网停电后由电梯自动应急平层装置供电运行到达最近层站的平层位置开门，让乘客安全离开轿厢。
In case of power cut, automatic emergency leveling device will generate power and support the elevator to reach the nearest landing floor, open the door after leveling, let passengers get out the car safety.

● 再平层功能 Re-leveling function

电梯停在当前层，当过多乘客进入电梯或离开电梯时，由于钢丝绳的伸长或缩短，轿厢脱离平层区域，电梯将在开门的情况下以低速运行至平层位置。
If the elevator parks at the current floor, when too much passengers enter into / leave the elevator, because wire rope extends or shortens, the car is separated from the leveling zone. The elevator will then travel to the leveling position at low speed under the condition of door-opening.

龙门架式家用电梯土建图

Portal frame house hold elevator construction plan

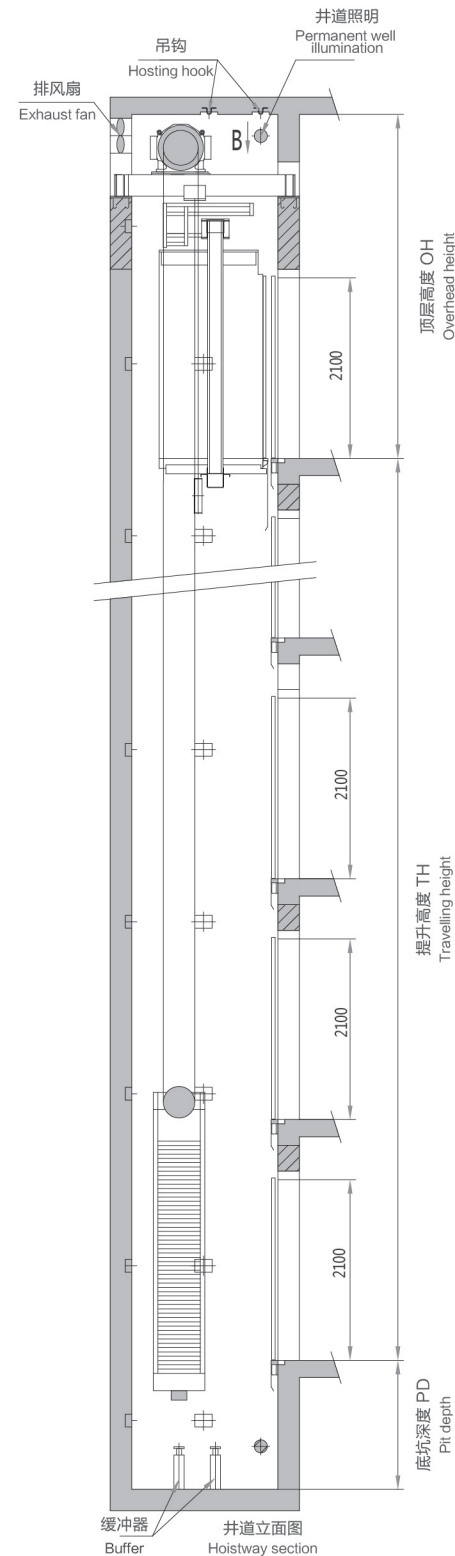
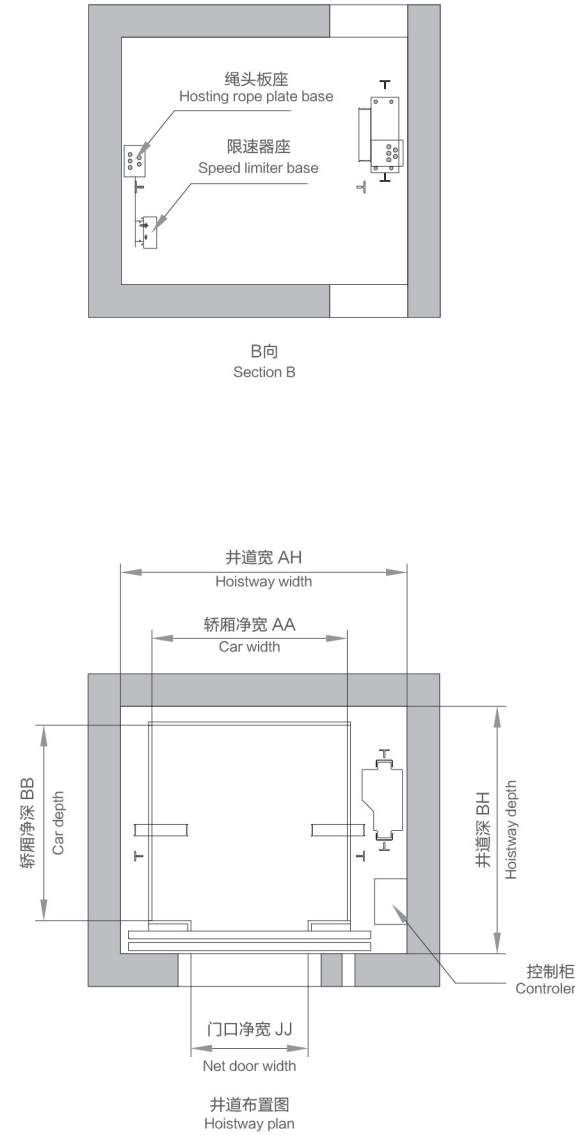

全国分公司服务网络 National Branch Service Network

辽宁分公司

销售热线: 024-31981333 传真: 024-31981222
地址: 沈阳市大东区滂江街26-1国际公寓2916

大连分公司

销售热线: 0411-86552277 传真: 0411-86552299
地址: 大连市中山区民康街15号报业大厦16层E

盘锦分公司

销售热线: 0427-2828611 传真: 0427-2829611
地址: 辽宁省盘锦市兴隆台区大商新玛特C座2102室

黑龙江分公司

销售热线: 0451-82346098 传真: 0451-82318292
地址: 黑龙江省哈尔滨市道里区群力第四大道399号汇智广场西楼1004室

吉林分公司

销售热线: 0431-86770000 传真: 0431-81030300
地址: 长春市经济技术开发区临河街5445号圣豪汇商705室

北京分公司

销售热线: 010-65505559 传真: 010-65505562
地址: 北京市朝阳区八里庄西里97号住邦2000商务中心4号楼10层

内蒙古分公司

销售热线: 0471-6289116 传真: 0471-6922767
地址: 呼和浩特市回民区新华西街明泽广场A座21层2110室

河北分公司

销售热线: 0311-66792031 转 8002 传真: 0311-87893130
地址: 石家庄市建设南大街29号众鑫大厦818-820室

天津分公司

销售热线: 022-58306090 传真: 022-58306091
地址: 天津市红桥区光荣道与保康路交口宝能创业中心B座24层2412室

山西分公司

销售热线: 0351-8371869 传真: 0351-8371859
地址: 太原市小店区平阳路1号金茂国际数码中心A座16层F室

陕西分公司

销售热线: 029-88332244 传真: 029-88332244-831
地址: 西安市莲湖区唐延路北段22号金辉国际广场11层

甘肃分公司

销售热线: 0931-8811752 传真: 0931-8432645
地址: 甘肃省兰州市城关区澳兰名门B2座708室

新疆分公司

销售热线: 0991-4815313 传真: 0991-4815795-815
地址: 新疆乌鲁木齐沙依巴克区友好北路793号高地中心1105室

河南分公司

销售热线: 0371-60189221
地址: 郑州市郑东新区康平路永平路郑东商业中心写字楼一号楼17楼1707

山东分公司

销售热线: 0531-55693961 传真: 0531-55693965
地址: 济南市市中区经四路13号万达广场C座办公楼2606室

青岛分公司

销售热线: 0532-68890088 传真: 0532-89092106
地址: 青岛市市北区山东路177号鲁邦广场B座1106-1107

烟台分公司

销售热线: 0535-6887005 传真: 0535-6887005
地址: 山东省烟台市莱山区银海路566号南山世纪华府13-2-2802

南京分公司

销售热线: 025-58812988 传真: 025-84519155-81
地址: 南京市洪武路359号福鑫大厦西2602室

苏州分公司

销售热线: 0512-65166725 传真: 0512-65166721
地址: 苏州工业园区苏虹中路225号星虹国际1幢2113室

无锡分公司

销售热线: 0510-85861251 传真: 0510-85861252
地址: 无锡市滨湖区梁青路58号华邸国际大厦A座1501室

徐州分公司

销售热线: 0516-83919000 传真: 0516-83919005
地址: 徐州市庆丰路绿地城市广场瀛海写字楼A座706室

上海分公司

销售热线: 021-62828058/62827558 传真: 021-62828360
地址: 上海市延安西路1221号2203室

浙江分公司

销售热线: 0571-89971040 传真: 0571-86590365
地址: 杭州市新塘路19号采荷嘉业5幢1204室

安徽分公司

销售热线: 0551-62671797 传真: 0551-62313639
地址: 安徽省合肥市蜀山区望江西路69号西湖国际广场A座603室

芜湖分公司

销售热线: 0553-3856158
地址: 芜湖市镜湖区长江中路66号 徽商财富广场北楼1802室

江西分公司

销售热线: 0791-88223016 传真: 0791-88399056
地址: 南昌市高新开发区紫阳大道绿地新都会紫峰(幢)大厦写字楼34层3402室

湖北分公司

销售热线: 027-82660063 传真: 027-85770699
地址: 武汉市江汉区淮海路中段泛海国际SOHO城2605-2606室

襄阳分公司

销售热线: 0710-3287220 传真: 0710-3287220
地址: 襄阳市高新区长虹北路万达广场1栋二单元1902室

湖南分公司

销售热线: 0731-85787755 传真: 0731-85787722
地址: 长沙市岳麓区岳麓大道57号奥克斯广场B座1127-1129

重庆分公司

销售热线: 023-67877015 传真: 023-67877025
地址: 重庆市渝中区大坪正街160号万科锦程1栋26-6

四川分公司

销售热线: 028-61320037 传真: 028-87321179
地址: 四川省成都市高新区新世纪环球中心西区8-1-1707

云南分公司

销售热线: 0871-68355199 传真: 0871-68355299
地址: 云南省昆明市五华区人民中路36号如意大厦11A室

贵州分公司

销售热线: 0851-86515286 传真: 0851-86515286转81
地址: 贵阳市观山湖区金阳南路6号世纪城购物中心D栋写字楼23层5号

广西分公司

销售热线: 0771-5517626 传真: 0771-5505713
地址: 南宁市民族大道92-1号新城国际1401号

广东分公司

销售热线: 020-38021060 传真: 020-38021410
地址: 广州市天河区天河路625号天娱广场东塔1007-1008室

深圳分公司

销售热线: 0755-83865618 传真: 0755-83865618
地址: 深圳市福田区益田路3008号皇都广场A座1906室

珠海分公司

销售热线: 0756-2260550 传真: 0756-2260695
地址: 珠海市香洲区银桦路102号6栋优特科技大厦909室

福建分公司

销售热线: 0591-88596982 传真: 0591-88594630
地址: 福州市五一中路88号平安大厦21G

龙门架式(家用系列)技术规格表

Portal frame house hold elevator technical specification table

载重量 (Kg) Loading capacity	额定速度 (m/s) Rated speed	开门方式 (mm) Door opening width	开门宽度 (mm) Door opening width	开门高度 (mm) Door opening height	轿厢尺寸(mm) Car size			井道尺寸(mm) Hoistway size		顶层高度 (mm) Top floor height	底坑深度 (mm) Pit depth	最大停站数 (层) Max. travelling height	最大提升高度 (m) Max. travelling height
					宽 Width	深 Depth	高 Height	宽 Width	深 Depth				
250	0.4		700		900	1000		1650	1450				
320	0.4	中分门	800	2000	1100	1100	2100	1850	1500	3500	1100	5	12
400	0.4		800		1100	1300		1850	1700				
备注					轿厢净高 (不含吊顶)								